

# NAMIC<sup>®</sup> Fluid Management

## Product Catalog



# NAMIC<sup>®</sup> Fluid Management Products

## Our Commitment to You

Navilyst Medical will continue to innovate and improve the “Gold Standard” NAMIC Product Line, which over the past 30 years, cardiologists, radiologists, technicians and nurses have come to trust.

Our commitment to develop quality products has resulted in a broad product portfolio, available in both single sterile and Convenience Kits, designed to meet the true challenges of your lab.

We hold ourselves accountable to deliver solutions for our customers that enhance the quality of life for patients.



## Ordering Information

Place your order directly with Navilyst Medical Customer Service by mail, telephone, fax or Electronic Data Interchange (EDI).

**Navilyst Medical, Inc.**  
**10 Glens Falls Technical Park**  
**Glens Falls, NY 12801**

**Phone:** 800.833.9973

**Fax:** 800.782.1357

**Hours:** Customer Service is available from 8:00 am EST to 7:00 pm EST weekdays excluding national holidays.

# Table of Contents

<b>Manifolds</b>	
Compensator™/Perceptor® Manifolds	1
Regular Manifolds	2
Traditional/Monitoring Manifolds	2
<b>Disposable Transducers and Accessories</b>	
Disposable Transducers	3
Accessories	3
Mounting Plates and Clamps	3
Reusable Transducer Cables	4
Arterial Line Kits	6
Perceptor Manifold - Compensator Manifold - Perceptor DT	7
<b>Syringes</b>	
Angiographic Control Syringes	8
Radiology Control/Medication Syringes	8
Polycarbonate	8
Polypropylene	9
<b>Pen and Label Set</b>	10
<b>Fluid Delivery Sets</b>	
IV Tubing: Spike Head	11
IV Tubing: Drip Chamber	11
Large Bore Tubing	12
<b>Contrast Management Systems</b>	
Squeeze Contrast Controller™	13
Non-chambered Contrast Management Systems	13
Mini-spike	13
<b>Closed Fluid Systems</b>	
Protection Station® and Bifurcated Protection Station	14
Protection Station Plus	14
Protection Station Plus with Contrast Management	15
Angio-Sac® Collection System	15
<b>Standard Kits</b>	
Radiology	16
Cardiology	16
Standard Radiology and Right Heart Catheterization	16
<b>Contrast Injection Lines</b>	
LPCIL (Low Pressure Contrast Injection Line)	17
HPCIL (High Pressure Contrast Injection Line)	17
clearaCIL™ High Pressure Contrast Injection Line	18
flexCIL® High Pressure Contrast Injection Line	18
<b>Pressure Monitoring Lines</b>	
Adult Lines	19
Pediatric Lines	19
Extension Sets with Stopcocks	20
<b>Stopcocks</b>	21
<b>Guidewires</b>	
Fixed Core Straight	22
Fixed Core J-Tip	22
Fixed Core Exchange	23
Movable Core J-Tip	23
<b>Interventional Devices and Accessories</b>	
Inflation Devices	24
Y-Adaptors and Tri-Adaptors	25
Torque Devices	25
Guidewire Introducers	25
Essentials™ Kit	26
<b>Table Covers, Patient Drapes, and Fluoroscope Covers</b>	27
<b>Miscellaneous Products</b>	
Needles	28
Caps	29
Waste Containers, Sharps Containers	29
Scalpels	29
Scissors, Gauze, Forceps	29
Connectors and Adaptors	29
Other Miscellaneous	29

Manifolds provide access to saline, contrast and pressure monitoring.

## Standard Specifications

Body Material	Clear Polycarbonate
Handle Material	Acetal
I.D. of Lumen	0.093"

### 1. Compensator™/Perceptor® Manifolds

- **Widespaced finger grip body style**
  - Can be controlled by single operator within sterile field
  - Reduced number of stopcock turns
  - Simplifies set up, easy to use
- **Integral transducer on port closest to rotating adaptor**
  - 1A. Compensator Manifold:** Uses a Pressure Monitoring Line (PML) off the Compensator port to “compensate” for the difference in manifold height.
    - Can take pressure readings at any level, as the end of the PML is at heart level on the pole
    - 387% increase in waveform fidelity due to closer proximity to heart
  - 1B. Perceptor Manifold:** Does not use a Pressure Monitoring Line, so manifold must be at heart level when taking pressure readings.

### 2. Regular Manifold

- Block or finger grip body style

### 3. Traditional/Monitoring Manifold

- Block style
- All female ports
- Manifold is mounted on the pole

## Options

### Number of Side Ports

- Compensator/Perceptor: 1, 2, 3, 4
- Regular: 2, 3, 4
- Traditional: 2, 3, 4, 5

### Port Orientation

- Right or Left-handed

### Body Styles

- Finger Grip: Cut-outs for fingers between handles
- Block: No cut-outs for fingers between handles

### Spacing Between Finger Grip Handles

- Wide space: 1.625"
- Regular space: 1.412"

### Standard Handle Position/Color

- ON: Pale Blue
- OFF: White

### Handle Style

- Regular

### Fittings

- Compensator, Perceptor, and Regular Manifolds: Female fittings w/swaged Rotating Adaptor on one end port
- Monitoring/Traditional Manifolds: All female fittings

### Pressure Rating

- Medium Pressure: 200 psi Static
- High Pressure: 500 psi Static

### Handle Routing

- R2 Routing: ON handles turn from 6 to 12 o'clock  
OFF handles turn from 3 to 9 o'clock
- R3 Routing: Either handle style turns 360 degrees

### 1A. Compensator Manifolds\*





Example	Number of Ports	Left/Right Handed	ON/OFF Handles	Pressure	Customer Order Part Number	
					Convenience Kit Part Number	Single Sterile Part Number
<p>*Order pressure monitoring line separately</p>	1	Right	OFF	Medium	40258107	70058107
	2	Right	OFF	Medium	40258207	70058207
	3	Right	OFF	Medium	40258307	70058307
	4	Right	OFF	Medium	40258407	70058407
	1	Right	ON	Medium	40258108	70058108
	2	Right	ON	Medium	40258208	70058208
	3	Right	ON	Medium	40258308	70058308
	4	Right	ON	Medium	40258408	70058408
	2	Left	OFF	Medium	40258217	70058217
	4	Left	OFF	Medium	40258417	70058417

### 1B. Perceptor Manifolds

Example	Number of Ports	Right/Left Handed	ON/OFF Handles	Pressure	Customer Order Part Number	
					Convenience Kit Part Number	Single Sterile Part Number
	1	Right	OFF	Medium	40238107	70038107
	2	Right	OFF	Medium	40238207	70038207
	3	Right	OFF	Medium	40238307	70038307
	4	Right	OFF	Medium	40238407	70038407
	1	Right	ON	Medium	40238108	70038108
	2	Right	ON	Medium	40238208	70038208
	3	Right	ON	Medium	40238308	70038308
	4	Right	ON	Medium	40238408	70038408
	2	Left	OFF	Medium	40238217	70038217
	3	Left	OFF	Medium	40238317	70038317
	4	Left	OFF	Medium	40238417	70038417
	1	Right	OFF	High	40337107	64037107
	3	Right	OFF	High	44039307	64039307

# Manifolds

## 2. Regular Manifolds

Examples	Body Style	Handle Style	Number of Ports	Right/Left Handed	ON/OFF Handles	Pressure	Customer Order Part Number	
							Convenience Kit Part Number	Single Sterile Part Number
 As shown: 70038202	Finger Grip	Regular	2	Right	OFF	Medium	40238200	70038200
	Finger Grip	Regular	2	Right	ON	Medium	40238202	70038202
	Finger Grip	Regular	3	Right	OFF	Medium	40238301	70038301
	Finger Grip	Regular	3	Right	ON	Medium	40238303	70038303
	Finger Grip	Regular	4	Right	OFF	Medium	40238402	70038402
 As shown: 70036301	Finger Grip	Regular	4	Right	ON	Medium	40238404	70038404
	Finger Grip	Regular*	2	Right	OFF	Medium	40236200	70036200
	Finger Grip	Regular*	2	Right	ON	Medium	40236202	70036202
	Finger Grip	Regular*	3	Right	OFF	Medium	40236301	70036301
	Finger Grip	Regular*	3	Right	ON	Medium	40236303	70036303
	Wide	Star	2	Right	OFF	Medium	40338200	64038200
	Wide	Star	2	Right	ON	Medium	41338202	64038202
	Wide	Star	3	Right	OFF	Medium	40338301	64038301
	Wide	Star	3	Right	ON	Medium	41338303	64038304
	Wide	Star	4	Right	OFF	Medium	40338402	64038402
 As shown: 64038404	Wide	Star	4	Right	ON	Medium	41338404	64038404
	Block	Regular	2	Right	OFF	Medium	40239200	70039200
	Block	Regular	2	Right	ON	Medium	40239202	70039202
	Block	Regular	3	Right	OFF	Medium	40239301	70039301
	Block	Regular	3	Right	ON	Medium	40239303	70039303
	Block	Regular	4	Right	OFF	Medium	40239402	70039402
	Block	Regular	4	Right	ON	Medium	40239404	70039404
	Block	Regular	2	Right	OFF	High	40237200	70037200
	Block	Regular	2	Right	ON	High	40237202	70037202
	Block	Regular	3	Right	ON	High	40338314	Not Available
 As shown: 70039402	Block	Regular	3	Right	OFF	High	40237301	70037301
	Block	Regular	3	Right	ON	High	40237303	70037303
	Block	Regular	4	Right	OFF	High	40237402	70037402
	Block	Regular	4	Right	ON	High	40237404	70037404
	Finger Grip	Regular	2	Left	OFF	Medium	40238212	70038212
	Finger Grip	Regular	3	Left	OFF	Medium	40238313	70038313
	Finger Grip	Regular	4	Left	OFF	Medium	40238414	70038414
	Block	Regular	2	Left	OFF	Medium	40239212	70039212
	Block	Regular	3	Left	OFF	Medium	40239313	70039313
	Block	Regular	4	Left	OFF	Medium	40239414	70039414
 As shown: 70039313	Block	Regular	2	Left	OFF	High	40237212	70037212
	Block	Regular	3	Left	OFF	High	40237313	70037313
	Block	Regular	4	Left	OFF	High	40237414	70037414

\* 6" Extension

## 3. Traditional Manifolds

Example	Total Ports*	Side Ports	Port Fittings	Handle Style	ON/OFF Handles	Customer Order Part Number	
						Convenience Kit Part Number	Single Sterile Part Number
 As shown: 70039355	4	2	All Female	Regular	OFF	40239352	70039352
	5	3	All Female	Regular	OFF	40239353	70039353
	6	4	All Female	Regular	OFF	40239354	70039354
	7	5	All Female	Regular	OFF	40239355	70039355

\*Includes both end ports

# Disposable Transducers and Accessories

Disposable Transducers are typically used to measure invasive pressures.\*

## Products and Accessories

1. Disposable Transducers
2. Mounting Plates and Clamps
3. Reusable Transducer Cables
4. Arterial Line Kits

\*100% Tested for Accuracy

## Options

### Assemblies

- With or without bonded stopcocks

### Cable Lengths

- 24" or 48"

## Part Numbers

### 1. Disposable Transducers

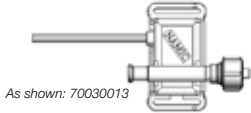
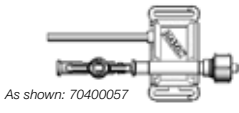
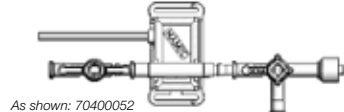
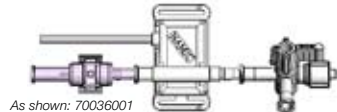

Examples	Stopcocks	Cable Length	Convenience Kit Part Number	Customer Order Part Number
				Single Sterile Part Number
	None	24"	40030013	70030013
	None	48"	40030014	70030014
	1-way	48"	40400057	70400057
	1-way and 3-way	24"	40400052	70400052
	3-way plus 3 ml/hr flush device	24"	40400050	70036001
	3-way and 1-way	24"	Not Available	70400055

### 2. Mounting Plates and Clamps



(Not available within Convenience Kits – Order Single Sterile – Reusable)

If using the Compensator Manifold, the end of the PML will hook into the "U" cut-outs on the Mounting Plate

#### 2A. Holders

Examples	Description	Customer Order Part Number
	Holder for single monitoring manifold	64000270
	Mounting Plate, holds 2 pole-mounted DTs or PML tubing for Compensator	70030152
	Mounting Plate, holds 4 DTs (2 of the 70030152 bonded together)	64000153

#### 2B. Clamps

Examples	Description	Customer Order Part Number
	Plastic Clamp, holds DT in vertical position	70030051
	Metal Clamp, holds DT in vertical position	70030053
	Metal Clamp, holds DT in horizontal position	70030054

continued on next page

# Disposable Transducers and Accessories

## 3. Reusable Transducer Cables

(Not available in Convenience Kits – Order Single Sterile – Reusable)

Hemodynamics/Monitoring System Manufacturer/Source	Series Names and Model Numbers (* indicates availability in non-standard size(s), shown in separate list below)	Customer Order Part Number	
		Single Sterile Part Number	
		6'	12'
Air Shields	AS-8	70040618	70041208
Air Shields	800, AS-100	70040626	70041216
American Optical/Picker	1006, 1008, 1016, 1131, 1131A, 1131B, and 1600	70040622	70041212
American Optical/Picker	All other models	70040618	70041208
Aries	700 Balloon Pump	70040630	70041220
Arrow International/Kontron	Balloon Pump (KAAT2)	Not Available	64000985
Astro Med	K3 Monitor	Not Available	64042044
Bard	Stamp Amplifier	Not Available	64000988
Bard	CPS Transak System, 8000	70040621	70041211
BD/Electrodyne	ST419	64042018	64042026
Biomedical Instrumentation	All Models	70040617	70041207
Bloom	Electrophysiology System (Model BERS - A/D)	70040611	70041201
Camtronics	PDM (Patient Data Module) 3.X	64042051	64042050
Camtronics/Emageon - PDM		64042051	64042050
Cardian III	CR6BT	Not Available	64042017
Cardiolab	ART-4 Monitor	Not Available	64042014
Cardiolab	ART-1, ART-2	Not Available	64042029
Cobe	CPC COBE Pump	Not Available	64042015
Colin	BP-408, CMB3000	70040618	70041208
Corometrics	506, 515, and 515A	64000998	Not Available
Criticare	508, 1100	70040621	70041211
Criticare	Scholar®	64042040	Not Available
Dantek	Urodyne 5000 Monitor	Not Available	64042025
Datamedix	Guardian®	64042018	64042026
Datascope	All except Point of View. Models include 97, 870, 2000, 2002, 3000, and Systems 90, 90T, 83, and 84, Passport EL, CS100® and 98XT	70040618	70041208
Datascope Balloon Pump		Not Available	64000985
Datex	Cardiocap® 1, Cardiocap 2, and Puritan Bennet® PB 245P. Models include CH1RS, CH2, CH2S, CG2, CG2S, CG2CS	Not Available	64000999
Drager	North American, all models	70040621	70041211
EP	Work Mate®	Not Available	64042043
Fukada Denshi	DS 3300	Not Available	64042016
GE	CGR 1000	Not Available	64042019
Gould	Statham Monitors. Models include IM-1000, JM-1014, IM-1024	70040626	70041216
Gould	Cath 2000 Monitor, TA 240 Easy Graf, 13-6615-50 Amplifier	Not Available	64042012
Hellige	SMK 155-9. Also for use with Servimed modules 236-015, 236-016, 236-037	Not Available	64042022
Hellige	PPG 23607601; SMU Series	Not Available	64042009
Hewlett Packard	HP 78205B	Not Available	70041208
Hewlett Packard	HP 8805B	Not Available	64042033
Hewlett Packard	Models with Twin-Ax Connector, 8890B, 8823, 700309A*	70040612	70041202
Hewlett Packard/Phillips Medical Intellivue	Rifle Shot (Models 7834_, 7833_), Mini Shot (Models 7835_, 78534B), Neo Shot (Models 788_78532A), Haemosphere, Solar® 8000 and 9500*	70040613	70041203
HME	HME Monitor	Not Available	64042034
J & J - Critikon	Dyna Map Plus, 8720, 8700, 9720	Not Available	64042021
JF Medical	Cares Monitor	Not Available	64042020
Kone	All Models	Not Available	64000999

continued on next page



# Disposable Transducers and Accessories

## 3. Reusable Transducer Cables (cont.)

Hemodynamics/Monitoring System Manufacturer/Source	Series Names and Model Numbers (* indicates availability in non-standard size(s), shown in separate list below)	Customer Order Part Number	
		Single Sterile Part Number	
		6'	12'
Kontron	Kontron 2000 Balloon Pump Monitors and Models 7131 and 7132	70040632	70041222
Kontron	Kontron KAAT, KAAT 2+ Balloon Pump, AKAAT 1 Plus	Not Available	64000985
Kontron	Kontron Monitors with Burndy Connector	70040627	70041217
Kontron	Kontron Monitors with Cannon Connector	70040623	70041213
Arrow International/Kontron Balloon Pump (KAAT2)		Not Available	64000985
Life-Tech	Waveform Processor	64000990	Not Available
Lohmeier	Lohmeier Monitor	Not Available	64042035
Mansfield	Mansfield 3000 Series	70040618	70041208
Marquette	Marquette GE PDS 3000	70040620	70041210
Marquette	Monitor Marquette 7000 Series and Marquette 7200 TRAM®, Marquette 2000 Series. Models include 7005 and 7010.	70040624	70041214
Marquette (circular pin out)		70040624	70041214
Marquette	Marquette TRAM® Series (L00) Models include: TRAM 100, 200, 300, 400, 500, 600, MQ-2, Unity and MacLab Eagle, 12C, Tramscope 12, Solar® (8000 Series), MacLab® 7000 and IT*	Not Available	70041223
Marquette Tram or MacLab 7000 (rectangular pin out)		64040633	70041223
MedCon	Windsurfer Station	64042051	64042050
Medcon/McKesson Windsurfer/TCS Symphony		64042051	64042050
Medical Data Electronics (MDE)	Models with HP Option	70040613	70041203
Medical Data Electronics (MDE)	All models except those with HP Option	70040621	70041211
Mennen	Mennen 400 Series, 700 Series, and Horizon Series IVY Biomedical models include 426, Transport 741 and 742; Horizon 1100, 2000, 2110, 3000, and 9000	70040621	70041211
Narco Med	Distributes Datascope Monitors	70040618	70041208
NEC	Model 1257	Not Available	64042028
Nihon Kohden	Nihon Kohden Lifescope Series & Model AP800PA Models include Lifescope 6 (OEC-1605A), Lifescope 8 (OEC-8108A), Lifescope 9 (BSM-8301A & BSM-8302A), Lifescope 11 (OMP-7201C & OMP-7203C), Lifescope 12 (BSM-8500 & BSM-8500A)	70040625	70041215
Nippon Colin	BP608	Not Available	64042049
Ohio	All Models	Not Available	64042018
Ohmeda	Modulus CDVC	70040629	70041219
Phillips	IntelliVue®*	70040613	70041203
HP/Phillips Medical IntelliVue		70040613	70041203
Physio-Control	Physio-Control VSM-1, VSM-4*	70040630	70041220
Physio-Control	Physio-Control VSM-5	Not Available	64042004
PPG Biomedical/E for M/Honeywell	E for M with Pins on Cable	Not Available	64042006
PPG Biomedical/E for M/Honeywell	PPG Biomedical: Vicom Monitor, Hellige 23607601 Monitor	Not Available	64042009
PPG Biomedical/E for M/Honeywell	E for M 7-Pin Amphenol Connector	Not Available	64042005
PPG Biomedical/E for M/Honeywell	PPG Biomedical RM 300	Not Available	64000984
PPG Biomedical/E for M/Honeywell	VR, AR, EVR, IM, OM, CCO Series and Bloom Electrophysiology System Model BERS-A/D. Models include VR12, VR16, AR6, EVR-130, AND EVR-180 (Sockets)	70040611	70041201
PPG Biomedical/E for M/Honeywell	HoneywellMEDDARS Monitors, M380 (Pins)	70040615	70041205
PPG Biomedical/E for M/Honeywell	Honeywell: V Series (Pins)	70040622	70041212
Propaq	Propaq 104, Critikon Dyna Map Plus	Not Available	64000989
Propaq	Propaq 106 EL	Not Available	64042021
Prucka	CLAB II	Not Available	64042029
Prucka CLAB II with and without amplified		Not Available	64042029
Quinton	Quinton Q-Cath® Monitor	70040617	70041207
Quinton Q-Cath		70040617	70041207
Roche	All Models	70040618	70041208

continued on next page

# Disposable Transducers and Accessories

## 3. Reusable Transducer Cables (cont.)

Hemodynamics/Monitoring System Manufacturer/Source	Series Names and Model Numbers (* indicates availability in non-standard size(s), shown in separate list below)	Customer Order Part Number	
		Single Sterile Part Number	
		6'	12'
S & W	Diascope 8000 Trendscope	Not Available	6400999
Sarns	Sarns 9000 Monitor	Not Available	64045980
Schwarzer	210055 PD 14 Monitor	Not Available	64042046
Schiller/Physiolog	Argus PB-1000	Not Available	64042061
Schiller/Physiolog – Heartsuite w/V2		Not Available	64042061
Siemens/Draeger 15 pin		70040616	70041206
Siemens/Draeger 15 pin locking		Not Available	64020997
Siemens	Siemens Sirecust, Penta, Sirem, Sensis, and Infinity® Delta Monitors. Models include Sirecust 401, 402, 403, 404, and 404-1; Penta 630, 720, 730, 732, 960, 961, 1280, 1281, 1261, and 1201	70040614	70041204
Siemens Sensis 10 pin		70040614	70041204
Siemens	Siemens Sirecust 300	Not Available	64042010
Siemens	Siemens Micor, Sior, Ricor, and Mingograph Monitors; Cathcor Monitors (Cable with locking mechanism)	Not Available	64000997
Siemens	Siemens Micor, Sior, Ricor, and Mingograph Monitor; Cathcor Monitors	70040616	70041206
Soxil	Soxil Sentinel 2E Monitor	Not Available	64042036
Spacelabs/Tektronix/Vititech Invivo Research, Inc.	TC-SA	Not Available	64042023
Spacelabs/Tektronix/Vititech Invivo Research, Inc.	Spacelabs 400, 500, 600, 9030_, and 9060_ Series; Vitatech Monitors 90431; Omni Trac-TV5, PC-2; and Spacelabs 904270-20	70040621	70041211
Spacelabs/Tektronix/Vititech Invivo Research, Inc.	Spacelabs Alpha 14 and Alpha 19	70040619	70041209
Spacelabs/Tektronix/Vititech Invivo Research, Inc.	Tektronix 400 Series Monitors	70040628	70041218
Trex Net	IMAC	Not Available	64042048
Witt Biomedical	With Cannon Connector	Not Available	64042003
Witt Biomedical	Series IV Digital Front End Monitor*	64042053	64042054
Witt Digital Series II Front End		64042053	64042054
Witt Biomedical	Series IV - Analog	70040611	70041201
Witt Analog System Series IV		70040611	70041201

## 4. Arterial Line Kits

Examples	Description	Customer Order Part Number
		Single Sterile Part Number
 <p>As shown: 70036148</p>	48" Adult Arterial Line Kit with 3 ml/hour Flush Device	70036148
	60" Adult Arterial Line Kit with 3 ml/hour Flush Device	70036160
	48" Trifurcated Adult Arterial Kit with 3 ml/hour Flush Device	70036348

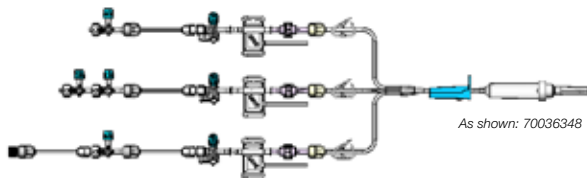

continued on next page

# Disposable Transducers and Accessories

## 5. Perceptor® Manifold – Compensator™ Manifold – Perceptor DT

Performance Specifications	
Operating Pressure Range	-30 to +300 mmHg
Operating Temperature Range	15° to 40° C
Excitation	4 to 8 VDC to 5kHz
Excitation Impedance	350 ohms ± 10%
Signal Impedance	300 ohms ± 10%
Sensitivity	5.0 $\mu$ V/V/mmHg ± 1%
Nonlinearity and Hysteresis	$\pm$ 1 mmHg plus 1% of reading from -30 to 50 mmHg $\pm$ 2% of reading from 51 to 300 mmHg
Zero Offset	$\pm$ 30 mmHg
Zero Drift	$\pm$ 1 mmHg/8 hours
Zero Thermal Drift	$\pm$ 0.3 mmHg/°C
Sensitivity Thermal Drift	$\pm$ 0.1%/°C
Overpressure	-400 to +4000 mmHg
Natural Frequency	$\geq$ 200 Hz for transducer alone
Leakage Current	< 2 $\mu$ Amps at 120V RMS 60 Hz
Defibrillator Withstand	5 discharges/5 minutes of 360 Joules into 50 ohm load
Mechanical Shock	Withstands 3 drops from 1 meter
Light Sensitivity	< 1 mmHg when exposed to 3000 foot-candles from a 3400° K tungsten light source

Meets or exceeds ANSI/AAMI BP22 Standard for Blood Pressure Transducers

# Syringes

Syringes are typically used for aspiration and injection of saline or contrast.

## Options 1. Angiographic Control Syringes







<b>Used to Inject</b>	Saline Contrast
<b>Material</b>	Polycarbonate (Hard, Clear)
<b>Barrel Size</b>	8, 10, 12, and 20 ml
<b>Plunger Style</b>	Palm Pad Thumb Ring
<b>Barrel Style</b>	Finger Grip Finger Ring
<b>Fitting</b>	Male Luer Lock (MLL) Swaged Rotating Adaptor (RA)
<b>0.5 ml Reservoir</b>	With or Without
<b>Piston Color</b>	White

## 2. Radiology Control/Medication Syringes

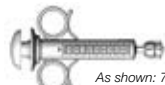



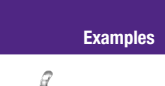

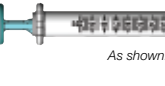
Saline Contrast Medication
<b>2A. Polycarbonate</b> (Hard, Clear) <b>2B. Polypropylene</b> (Soft, Cloudy)
1, 3, 5, 6, 10, 12, 20, 30, 35 and 60 ml
Flat Pad
Finger Grip: Long Wings Short Wings
Male Luer Lock (MLL) Male Slip Tip (MST)
With or Without
Pale Blue, Bright Blue, Yellow, Purple, Green, Red, White, Clear, and Gray

## Part Numbers

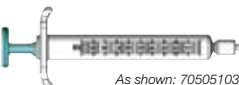
### 1. Angiographic Control Syringes

Examples	Barrel Size	Plunger Style	Barrel Style	Fitting	0.5 ml Reservoir	Customer Order Part Number	
						Convenience Kit Part Number	Single Sterile Part Number
 As shown: 70095007	8 ml	Thumb Ring	Finger Ring	Fixed MLL	Yes	10127090	70027090
	10 ml	Thumb Ring	Finger Ring	Fixed MLL	Yes	40085003	70085003
 As shown: 70095107	10 ml	Thumb Ring	Finger Ring	Rotating Adaptor	Yes	40085007	70085007
	10 ml	Thumb Ring	Finger Ring	Extended RA	Yes	40085005	70085005
 As shown: 70095107	10 ml	Palm Pad	Finger Ring	Fixed MLL	Yes	40095003	70095003
	10 ml	Palm Pad	Finger Ring	Rotating Adaptor	Yes	40095007	70095007
 As shown: 70087007	12 ml	Palm Pad	Finger Grip	Rotating Adaptor	Yes	40095107	70095107
	12 ml	Thumb Ring	Finger Ring	Fixed MLL	Yes	40087003	70087003
 As shown: 70087007	12 ml	Thumb Ring	Finger Ring	Fixed MLL	No	40088003	70088003
	12 ml	Thumb Ring	Finger Ring	Rotating Adaptor	Yes	40087007	70087007
 As shown: 70087007	12 ml	Thumb Ring	Finger Ring	Fixed MLL	No	40088007	70088007
	12 ml	Palm Pad	Finger Ring	Rotating Adaptor	Yes	40097007	70097007
 As shown: 70097003	12 ml	Palm Pad	Finger Ring	Fixed MLL	Yes	40097003	70097003
	12 ml	Palm Pad	Finger Grip	Rotating Adaptor	Yes	40097107	70097107
 As shown: 70075027	20 ml	Thumb Ring	Finger Ring	Fixed MLL	Yes	40075023	70075023
	20 ml	Thumb Ring	Finger Ring	Rotating Adaptor	Yes	40075027	70075027

### 2A. Radiology Control/Medication Syringes: Polycarbonate

Examples	Wings	Piston Color	0.5 ml Reservoir	Barrel Size	Fitting	Customer Order Part Number	
						Convenience Kit Part Number	Single Sterile Part Number
 As shown: 70505103	Short	White	No	1 ml	MLL	10127566	Not Available
	Short	Pale Blue	No	10 ml	MLL	40506203	70506203
 As shown: 70506203	Long	Pale Blue	No	10 ml	MLL	40506103	Not Available
	Long	Pale Blue	Yes	10 ml	MLL	40505103	70505103
	Short	Bright Blue	No	10 ml	MLL	40506213	Not Available
	Long	Bright Blue	Yes	10 ml	MLL	40505113	Not Available
	Short	Yellow	No	10 ml	MLL	40506223	Not Available
	Long	Yellow	No	10 ml	MLL	40506123	Not Available
	Long	Yellow	Yes	10 ml	MLL	40505123	Not Available
	Short	Purple	No	10 ml	MLL	40506233	Not Available
	Long	Purple	Yes	10 ml	MLL	40505133	Not Available

continued on next page

## 2A. Radiology Control/Medication Syringes: Polycarbonate (cont.)

Customer Order

	Wings	Piston Color	0.5 ml Reservoir	Barrel Size	Fitting	Convenience Kit Part Number	Single Sterile Part Number
	Short	Green	No	10 ml	MLL	40506253	Not Available
	Long	Green	No	10 ml	MLL	40400501*	Not Available
	Long	Green	Yes	10 ml	MLL	40505153	Not Available
	Short	Red	No	10 ml	MLL	40506263	Not Available
	Long	Red	Yes	10 ml	MLL	40505163	Not Available
	Short	White	No	10 ml	MLL	40506273	Not Available
	Long	White	No	10 ml	MLL	40505173	Not Available
	Long	White	No	10 ml	MLL	40400502*	Not Available
	Short	Pale Blue	No	20 ml	MLL	10127128	Not Available
	Short	Yellow	No	20 ml	MLL	10127127	Not Available
	Short	Green	No	20 ml	MLL	10127126	Not Available
	Short	Red	No	20 ml	MLL	10127125	Not Available
	Short	White	No	20 ml	MLL	10127124	Not Available

\*Piston is removable

## 2B. Radiology Control/Medication Syringes: Polypropylene

Customer Order  
Part Number

Example	Rings/Wings	Piston Color	0.5 ml Reservoir	Barrel Size	Fitting	Convenience Kit Part Number	Single Sterile Part Number
	Short Wings	White	No	1 ml	MST	10127066	Not Available
	Short Wings	Clear	No	3 ml	MIL	10127067	Not Available
	Short Wings	Clear	No	3 ml	MST	10127121	Not Available
	Short Wings	Clear	No	3 ml	MLL/Safety	10045549	Not Available
	Short Wings	Clear	No	5 ml	MILL	10127068	Not Available
	Short Wings	Clear	No	5 ml	MST	10127122	Not Available
	Short Wings	Pale Blue	No	5 ml	MLL	10127610	Not Available
	Short Wings	Yellow	No	5 ml	MLL	10127620	Not Available
	Short Wings	Green	No	5 ml	MLL	10127650	Not Available
	Short Wings	Red	No	5 ml	MLL	10127660	Not Available
	Short Wings	Clear	No	6 ml	MST	10127505	Not Available
	3 Rings	Clear	No	10 ml	MLL	10127070	Not Available
	3 Rings	Pale Blue	No	10 ml	MLL	10127711	Not Available
	Short Wings	Pale Blue	No	10 ml	MLL	10127710	Not Available
	Short Wings	Pale Blue	No	10 ml	MST	10127810	Not Available
	Short Wings	Yellow	No	10 ml	MLL	10127720	Not Available
	Short Wings	Yellow	No	10 ml	MLL	10127820	Not Available
	Short Wings	Green	No	10 ml	MLL	10127750	Not Available
	Short Wings	Green	No	10 ml	MST	10127850	Not Available
	Short Wings	Red	No	10 ml	MLL	10127760	Not Available
	Short Wings	Red	No	10 ml	MST	10127860	Not Available
	Short Wings	Clear	No	10 ml	MLL	10127063	Not Available
	Short Wings	Clear	No	10 ml	MST	10127123	Not Available
	Short Wings	Clear	No	10 ml	MLL/Safety	10045339	Not Available
	Short Wings	Clear	No	12 ml	MLL	10127076	Not Available
	Short Wings	Clear	No	12 ml	MST	10127503	Not Available
	Short Wings	Clear	No	20 ml	MLL	10127072	Not Available
	Short Wings	Clear	No	20 ml	MST	10127563	Not Available
	Short Wings	Pale Blue	No	20 ml	MLL	10127910	Not Available
	Short Wings	Yellow	No	20 ml	MLL	10127920	Not Available
	Short Wings	Green	No	20 ml	MLL	10127950	Not Available
	Short Wings	Red	No	20 ml	MLL	10127960	Not Available
	Short Wings	White	No	20 ml	MLL	10127970	Not Available
	Short Wings	Clear	No	30 ml	MLL	10127078	Not Available
	Short Wings	Gray	No	35 ml	MLL	10127507	Not Available
	Short Wings	Gray	No	35 ml	MST	10127506	Not Available
	Short Wings	Clear	No	60 ml	MLL	10127077	Not Available



As shown: 10127660

# Pen and Label Set

## Clear Polypropylene Labels

### Standard Specifications

Set includes the following:

- **1 Permanent Marking Pen**
- **20 Medication-Specific Labels**
  - 4 Saline
  - 4 Contrast
  - 4 Heparin/Saline
  - 2 Heparin
  - 2 Nitroglycerin
  - 2 Lidocaine
  - 1 Adenosine
  - 1 Verapamil
- **10 Blank Labels**
- **Only available in Convenience Kits**

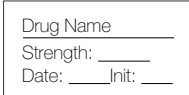
Label Format	Description	Convenience Kit Part Number	Single Sterile Part Number
	Permanent marking pen and medication label set	40400108	Not Available

Fluid Delivery Sets are used to administer saline and/or contrast.

## Standard Specifications

**Tubing** Clear PVC (Polyvinylchloride)  
**Fittings** Male Luer Lock  
**Pressure** Not Rated

## Options

**Spike or Drip**  
**Chamber Drip**  
**Tubing Length** 48", 60", 68", 72", 108", or 135"  
**Durometer** 80  
**ID** 0.118"  
**OD** 0.162"  
**Tubing Style** Single  
 Bifurcated  
 Trifurcated

## 2. Large Bore Tubing

Spike Head  
 N/A  
 72" or 108"  
 83  
 0.158"  
 0.214"  
 Single

## Part Numbers

### 1A. IV Tubing: Spike Head

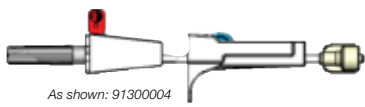
Example	Tubing Length	Tubing Style	Tubing Stripes	Vent	Convenience Kit Part Number	Customer Order Part Number	Single Sterile Part Number
 <p>As shown: 91300004</p>	48"	Single	—	Yes	40427038		Not Available
	68"	Bifurcated	—	Yes	40427059		Not Available
	72"	Single	—	Yes	40427004		91300004
	72"	Single	—	No	40427040		91300040
	72"	Single	Green	Yes	40429019		Not Available
	72"	Single	Red	Yes	40445254		Not Available
	108"	Single	—	Yes	40427007		91300007

### 1B. IV Tubing: Drip Chamber

Example	Tubing Length	Tubing Style	Tubing Stripes	Vent	Filter	Chamber Drip	Convenience Kit Part Number	Customer Order Part Number	Single Sterile Part Number
 <p>As shown: 91300052</p>	48"	Single	—	No	Yes	Macro	40427048		91300011
	48"	Bifurcated	—	No	No	Macro	10027012		91300012
	48"	Trifurcated	—	No	No	Macro	10027013		91300013
	60"	Bifurcated	—	No	Yes	Macro	40438285		Not Available
	60"	Trifurcated	—	No	Yes	Macro	40438325		Not Available
	72"	Single	—	No	Yes	Macro	10027052		91300052
	72"	Single	—	Yes	No	Macro	10029130		91300005
	72"	Single	—	Yes	Yes	Macro	49000053		Not Available
	72"	Single w/inj. port	—	No	No	Macro	40427019		64000130
	72"	Bifurcated	—	No	No	Macro	10027035		91300035
	72"	Bifurcated	—	No	Yes	Macro	10029203		Not Available
	108"	Single	—	No	Yes	Macro	10029118		Not Available
	135"	Single	—	No	Yes	Macro	40427028		99000070
	135"	Single	Red	No	Yes	Macro	49000225		Not Available
	135"	Single	Blue	No	Yes	Macro	49000226		Not Available

continued on next page

# Fluid Delivery Sets

## 1B. IV Tubing: Drip Chamber (cont.)

							Customer Order Part Number	
	Tubing Length	Tubing Style	Tubing Stripes	Vent	Filter	Chamber Drip	Convenience Kit Part Number	Single Sterile Part Number
	135"	Single	Yellow	No	Yes	Macro	49000227	Not Available
	135"	Single	Green	No	Yes	Macro	49000228	Not Available
	48"	Single	—	No	Yes	Micro	10027001	91300001
	135"	Single	—	No	Yes	Micro	40427015	99000069
	135"	Single	Red	No	Yes	Micro	49000221	Not Available
	135"	Single	Blue	No	Yes	Micro	49000222	Not Available
	135"	Single	Yellow	No	Yes	Micro	49000223	Not Available
	135"	Single	Green	No	Yes	Micro	49000224	Not Available

## 2. Large Bore Tubing

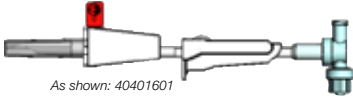
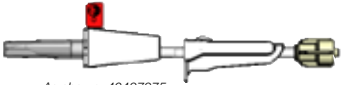
							Customer Order Part Number	
Examples	Tubing Length	Tubing Style	Vent	Pressurized	Convenience Kit Part Number	Single Sterile Part Number		
 <i>As shown: 40401601</i>	72"	Single	Yes	No	40427275	91300026		
	72"	Single	Yes	Sosa	41300031	91300021		
	108"	Single	Yes	Sosa	41300032	Not Available		
 <i>As shown: 40427275</i>	72"	Single w/Dual Back Check Valve	Yes	No	40401601	90500070		



Contrast Management Systems are designed to help manage and reduce contrast waste.

## Types of Systems

### 1. Squeeze Contrast Controller™ (Chambered)

- A two check valve tubing assembly with an in-line squeezable chamber
- Proven microbial barrier to prevent contamination of contrast source
- Allows one contrast source for multiple patient cases; saves money
- 12 ml chamber reduces contrast waste at end of procedure
- Safety air filter prevents particulate airborne contamination of contrast in chamber
- Fast-filling, flexible chamber and unique debubbling dish

### 2. Non-chambered

- A 72" line with 2 in-line check valves, with or without stopcock

### 3. Mini-spike



- Short spike is required for use with Contrast Management Systems
- Can be used on multiple patients (up to 6 hours)
- Typically ordered single sterile

## Part Numbers

### 1. Squeeze Contrast Controller (Chambered)

Example	Description	Customer Order Part Number	
		Convenience Kit Part Number	Single Sterile Part Number
 <p><i>As shown: 90400435</i></p>	Squeeze Contrast Controller, 72" IV tubing with green ball	40400435	90400435

### 2. Non-chambered

Examples	Description	Customer Order Part Number	
		Convenience Kit Part Number	Single Sterile Part Number
 <p><i>As shown: 40400018</i></p>	72" green striped IV tubing with 2 in-line check valves	40400018	Not Available
 <p><i>As shown: 64000010</i></p>	72" IV tubing with 2 in-line check valves and stopcock	40400010	64000010

### 3. Mini-spike

Example	Description	Customer Order Part Number	
		Convenience Kit Part Number	Single Sterile Part Number
 <p><i>As shown: 90400039</i></p>	Mini-spike Assembly	40400039	90400039

# Closed Fluid Systems

Closed Fluid Systems are designed to administer saline and/or contrast and collect and contain patient waste.

## Types of Systems

### 1. Protection Station® and Bifurcated Protection Station

- Closed system that administers saline and collects waste
- Can be used either on the manifold or off the manifold

### 2. Protection Station Plus

- Not typically used with a manifold
- Closed system that administers saline and contrast and collects waste

### 3. Protection Station Plus with Contrast Management





- Closed system that administers saline and contrast and collects waste
- Contains two in-line check valves, allowing mini spike to be used in multiple patients (up to six hours)

### 4. Angio-Sac® Collection System

- A waste bag that can be attached to the manifold or used off line

## Part Numbers

### 1. Protection Station and Bifurcated Protection Station

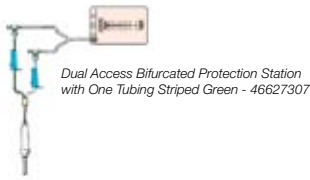
Examples	Description	Pressurized or Non-Pressurized	Convenience Kit Part Number	Customer Order Part Number
				Single Sterile Part Number
	Protection Station	Non-Pressurized	40400900	64000934
	Protection Station	Pressurized	40400950	Not available
	Protection Station with M-RA Adaptor	Non-Pressurized	40400900 w/10045242	64000944
	Protection Station with In-Line Stopcocks and M-RA Adaptor	Pressurized	40400950 w/40027180	64000936
	Bifurcated Protection Station with Clip	Non-Pressurized	40400904 w/10045242	94000904
	Bifurcated Protection Station with Clip and Reflux Valve	Pressurized	40400954 w/10045242 and 40400102	94000954
	Dual Access Bifurcated Protection Station with One Tubing Striped Green	Pressurized	46627307	Not Available

### 2. Protection Station Plus

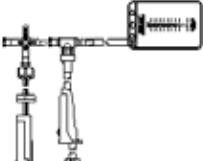

Example	Description	Pressurized or Non-Pressurized	Convenience Kit Part Number	Customer Order Part Number
				Single Sterile Part Number
	Protection Station Plus w/Green Striped Contrast Line	Non-Pressurized	40400910 w/40429019	64000935
	Protection Station Plus w/Green Striped Contrast Line and Strap Clip	Non-Pressurized	40400910 w/40429019 and 10045242	64000945

## 3. Protection Station® Plus with Contrast Management

Example	Description	Pressurized or Non-Pressurized	Convenience Kit Part Number	Customer Order Part Number Single Sterile Part Number
 <p>As shown: 64000955</p>	Protection Station Plus with Contrast Management	Non-Pressurized	40400910 w/40400010	Not Available
	Protection Station Plus with Contrast Management and Strap Clip	Non-Pressurized	40400910 w/40400010 and 10045242	—
	Protection Station Plus with Green Striped CM Line**	Non-Pressurized	40400911 w/40400018	64000955*

\*Need Mini-spike – order separately – item 90400039  
 \*\*Stopcock at bottom of CM line is a 4-way – turns 360°

## 4. Angio-Sac® Collection System

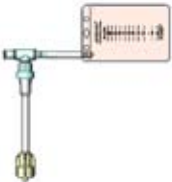
Examples	Description	Bag Size	Fitting	Check Valve	Convenience Kit Part Number	Customer Order Part Number Single Sterile Part Number
 <p>Angio-Sac w/ MLL 90500018</p>  <p>Angio-Sac w/ FLL 64000925</p>  <p>Angio-Sac w/ Check Valve, Drainage Clamp, Clip, and MLL 90500028</p>	Angio-Sac Collection System	1000 ml	MLL	No	10500026	90500018
	Angio-Sac (a.k.a. Brewer Sac)	1000 ml	FLL	Yes	40400906	64000925
	Angio-Sac Collection System with Drainage Clamp and Clip	1500 ml	MLL	Yes	40500028 w/10045242	90500028
 <p>Abscess Drainage Set 90500040</p>  <p>Palestrant Irrigation and Drainage Set 90500050</p>  <p>Filling Station 90500060</p>  <p>Filling Station Plus 90500065</p>	Abscess Drainage Set	1000 ml	—	—	Not Available	90500040
	Palestrant Irrigation and Drainage Set	1500 ml	—	—	40400940	90500050
	Filling Station	—	—	—	40400106 w/10027052, and 40427275	90500060
	Filling Station Plus	1000 ml	—	—	40400106 w/10027052, 40427275 and 10500026	90500065

# Standard Kits

## Products

1. Radiology: **Standard Closed Fluid Waste Management Systems**
2. Cardiology: **Standard Cardiovascular Kits**
  - 2A. Standard Angiographic Kit with NAMIC® Manifold
  - 2B. Standard Angiographic Kit with Perceptor® Manifold
3. Standard Radiology and Right Heart Catheterization

## Part Numbers

### 1. Radiology: Standard Closed Fluid Waste Management Systems

Description	Customer Order Part Number
Standard Protection Station® System	91310200
Standard Protection Station System with 10 cc Radiology Control Syringe	91310210
Standard Protection Station System with 10 cc Radiology Control Syringe and 48" flexCIL Contrast Injection Line	91310220
Standard Protection Station System with 10 cc Radiology Control Syringe, Polypropylene Syringes, and 48" flexCIL Contrast Injection Line	91310230
Standard Protection Station Plus System	91310300
Standard Protection Station Plus System with 10 cc Radiology Control Syringe	91310310
Standard Protection Station Plus System with 10 cc Radiology Control Syringe and 48" flexCIL® Contrast Injection Line	91310320
Standard Protection Station Plus System with 10 cc Radiology Control Syringe, Polypropylene Syringes, and 48" flexCIL Contrast Injection Line	91310330

### 2. Cardiology: Standard Cardiovascular Kits

#### 2A. Standard Angiographic Kit with NAMIC Manifold

Description	Customer Order Part Number
Three-Valve Classic (Clear) Manifold with Ports on Right and OFF Handles	91301301
Three-Valve Classic (Clear) Manifold with Ports on Right and ON Handles	91301303

#### 2B. Standard Angiographic Kit with Perceptor NAMIC Manifold

Description	Customer Order Part Number
Three-Valve Perceptor Manifold with Ports on Right and OFF Handles	91301307
Three-Valve Perceptor Manifold with Ports on Right and ON Handles	91301308

### 3. Standard Radiology and Right Heart Catheterization

Description	Cable Length	Customer Order Part Number
Stopcock End Port	48"	70030021
Stopcock Side Port	48"	70030020

Contrast Injection Lines are typically used to connect the power injector to the catheter or manifold, and can also be used as extension tubing between the manifold and catheter.

## Specifications

	1. LPCIL	2. HPCIL	3. clearaCIL™	4. flexCIL®
PSI Rating	500 psi	1000 psi	1200 psi	1200 psi
Flexibility	Medium	Low	Medium	High
Clarity	High	High	High	Medium
ID	0.089"	0.089"	0.071"	0.071"
OD	0.159"	0.188"	0.141"	0.142"
Material	PVC	PVC	Co-extruded Nylon/Urethane	Braided Polyurethane

## Options

### Standard Lengths

- 10", 20", 30" and 48"

### Other Lengths

- 60", 72", 80", and 96"

### Fittings

- Female Luer Lock (FLL) to Male Luer Lock (MLL)
- FLL to Rotating Adaptor (RA)
- MLL to MLL

## Part Numbers

### 1. LPCIL (Low Pressure Contrast Injection Line)

Example	PSI Rating	Length	Fittings	Customer Order Part Number	
				Convenience Kit Part Number	Single Sterile Part Number
 <p>As shown: 41021102</p>	500 psi	10"	FLL – MLL	41021102	91021102
	500 psi	10"	FLL – RA	49000153	Not Available
	500 psi	10"	MLL – RA	45632124	Not Available
	500 psi	20"	FLL – MLL	41021202	91021202
	500 psi	20"	FLL – RA	45632116	Not Available
	500 psi	20"	MLL – MLL	41022202	Not Available
	500 psi	30"	FLL – MLL	41021302	91021302
	500 psi	48"	FLL – MLL	41021482	91021482
	500 psi	48"	FLL – RA	45632106	Not Available
	500 psi	48"	MLL – MLL	41022482	Not Available
	500 psi	60"	FLL – MLL	41021602	Not Available
	500 psi	72"	FLL – MLL	41021722	Not Available
	500 psi	72"	MLL – MLL	41022722	Not Available

### 2. HPCIL (High Pressure Contrast Injection Line)

Example	PSI Rating	Length	Fittings	Customer Order Part Number	
				Convenience Kit Part Number	Single Sterile Part Number
 <p>As shown: 41001103</p>	1000 psi	10"	FLL – MLL	41011102	91011102
	1000 psi	10"	FLL – RA	41001103	91001103
	1000 psi	20"	FLL – MLL	41011202	91011202
	1000 psi	20"	FLL – RA	41001203	91001203
	1000 psi	30"	FLL – MLL	41011302	91011302
	1000 psi	30"	FLL – RA	41001303	91001303
	1000 psi	48"	FLL – MLL	41011482	91011482
	1000 psi	48"	FLL – RA	41001483	91001483
	1000 psi	60"	FLL – MLL	41011602	91011602
	1000 psi	60"	FLL – RA	41001603	91001603
	1000 psi	60"	MLL – MLL	41012602	Not Available
	1000 psi	72"	FLL – MLL	41011722	Not Available
	1000 psi	72"	FLL – RA	45632122	Not Available
	1000 psi	80"	FLL – RA	41001803	Not Available
	1000 psi	96"	FLL – MLL	41011962	Not Available

# Contrast Injection Lines

## 3. claraCIL™ High Pressure Contrast Injection Line

Customer Order Part Number

Example	PSI Rating	Length	Fittings	Convenience Kit Part Number	Single Sterile Part Number
 <p>As shown: 41001203</p>	1200 psi	10"	FLL – MLL	41011102	91031102
	1200 psi	10"	FLL – RA	41001103	91031103
	1200 psi	20"	FLL – MLL	41011202	91031202
	1200 psi	20"	FLL – RA	41001203	91031203
	1200 psi	30"	FLL – MLL	41011302	91031302
	1200 psi	30"	FLL – RA	41001303	91031303
	1200 psi	48"	FLL – MLL	41011482	91031482
	1200 psi	48"	FLL – RA	41001483	91031483

## 4. flexCIL® High Pressure Contrast Injection Line

Customer Order Part Number

Example	PSI Rating	Length	Fittings	Convenience Kit Part Number	Single Sterile Part Number
 <p>As shown: 41051103</p>	1200 psi	4"	FLL – MLL	41051042	Not Available
	1200 psi	10"	FLL – MLL	41051102	91051102
	1200 psi	10"	FLL – RA	41051103	91051103
	1200 psi	20"	FLL – MLL	41051202	91051202
	1200 psi	20"	FLL – RA	41051203	91051203
	1200 psi	30"	FLL – MLL	41051302	91051302
	1200 psi	30"	FLL – RA	41051303	91051303
	1200 psi	48"	FLL – FLL	41051481	Not Available
	1200 psi	48"	FLL – MLL	41051482	91051482
	1200 psi	48"	FLL – RA	41051483	91051483
	1200 psi	60"	FLL – MLL	41051602	91051602
	1200 psi	60"	FLL – RA	41051603	91051603
	1200 psi	72"	FLL – MLL	41051722	91051722
	1200 psi	72"	FLL – RA	41051723	91051723

# Pressure Monitoring Lines

Pressure Monitoring Lines (PML) are typically used to carry a patient's pressure to the transducer.

## Specifications

	1. Adult Lines	2. Pediatric Lines
ID	0.059"	0.044"
OD	0.128"	0.098"
Tubing Material	PVC (Polyvinylchloride)	
Pressure Rating	Not Rated (Note: Do not power-inject contrast through PML)	

## PML Options

### Fittings

- Female-Male or Male-Male

### Lengths

- 6", 12", 24", 36", 48", 60", 72", 84", and 96"

### Other

- Colored striped tubing may be available—Contact Customer Service.

## Part Numbers

### 1. Adult Lines

Example	Fittings	Length	Customer Order Part Number	
			Convenience Kit Part Number	Single Sterile Part Number
 <p>Adult Pressure Monitoring Line M-F</p>	Female-Male	6"	40701062	90701062
	Female-Male	12"	40701122	90701122
	Female-Male	24"	40701242	90701242
	Female-Male	36"	40701362	90701362
	Female-Male	48"	40701482	90701482
	Female-Male	60"	40701602	90701602
	Female-Male	72"	40701722	90701722
	Female-Male	84"	40701842	90701842
	Female-Male	96"	40701962	90701962
	Male-Male	12"	40702122	90702122
	Male-Male	24"	40702242	90702242
	Male-Male	36"	40702362	90702362
	Male-Male	48"	40702482	90702482
	Male-Male	60"	40702602	90702602
	Male-Male	72"	40702722	90702722
	Male-Male	84"	40702842	90702842
	Male-Male	96"	40702962	90702962

### 2. Pediatric Lines

Example	Fittings	Length	Customer Order Part Number	
			Convenience Kit Part Number	Single Sterile Part Number
 <p>Pediatric Pressure Monitoring Line M-F</p>	Female-Male	6"	40711062	90711062
	Female-Male	12"	40711122	90711122
	Female-Male	24"	40711242	90711242
	Female-Male	36"	40711362	90711362
	Female-Male	48"	40711482	90711482
	Female-Male	72"	40711722	90711722
	Male-Male	12"	40712122	90712122
	Male-Male	24"	40712242	90712242
	Male-Male	36"	40712362	90712362
	Male-Male	48"	40712482	90712482
	Male-Male	72"	40712722	90712722

# Pressure Monitoring Lines

## 3. Extension Sets with Stopcocks

Customer Order Part Number

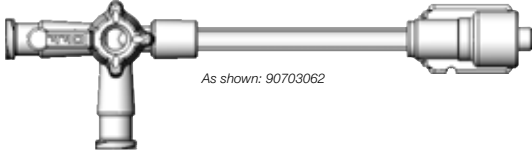
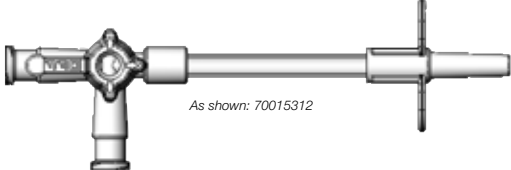
Examples	Patient Type	Tubing Length	Tubing Type	Body Style	Fitting	Convenience Kit Part Number	Single Sterile Part Number
 <p>As shown: 90703062</p>	Pediatric	4.5"	PML	3-way	MLL	40703050	90703050
	Adult	6"	PML	3-way	MLL	40703062	90703062
 <p>As shown: 70015312</p>	Adult	9"	PML	3-way	MLL	40703092	90703092
	Adult	12"	PML	3-way	MLL	40703122	90703122
	Adult	12"	IV	3-way	MST	40015312	70015312
	Adult	20"	IV	3-way	MST	40015320	70015320
	Adult	33"	IV	3-way	MST	40015333	70015333
	Adult	12"	IV	4-way	MST	40015412	70015412
	Adult	20"	IV	4-way	MST	40015420	70015420
	Adult	33"	IV	4-way	MST	40015433	70015433



Stopcocks are used as on/off valves.

## Standard Specifications

<b>Body Material</b>	Polycarbonate
<b>Handle Material</b>	Acetal
<b>ID of Lumen</b>	0.075"
<b>Fluid Uses</b>	Excludes Lipids

## Stopcock Types

### 1. Stopcock only

### 2. Extension Sets with Stopcocks

- Pediatric
- Adult

## Stopcock Options

### Body Styles

- 1-way: 1 Female 1 Male
- 3-way: 2 Female 1 Male
- 4-way: 2 Female 1 Male

### Handle Styles

- 1-way: Tee Handles
- 3 and 4-way: OFF Handles

### Handle Colors (Standard)

- White: Low Pressure
- Pale Blue: Medium Pressure
- Navy Blue: High Pressure
- Red: 4-way Low and Medium Pressure

### Pressure ratings

- Low Pressure: 200 psi
- Medium Pressure: 400 psi
- High Pressure: 1050 psi

### Fittings

- Female Luer Lock
- Rotating Collar: To tighten to stopcock
- Luer Lock: Allows no movement once attached
- Rotating Adaptor (RA): Allows uninhibited rotation once attached
- Male Slip Tip (MST)

## Extension Set Options

### Tubing Type

- Pediatric
- Adult
- IV

### Tubing Length



- Pediatric: 4.5"
- Adult: 6", 9"
- IV: 12", 20", or 33"

### Fitting Options

- MLL (Male Luer Lock)
- MST (Male Slip Tip)

## Part Numbers

### 1. Stopcocks

Examples	Body Style	Pressure	Male Fitting	Customer Order Part Number	
				Convenience Kit Part Number	Single Sterile Part Number
 As shown: 70055017	1-way	Low	MST	40015016	70015016
	1-way	Low	Rotating Collar	40015015	70015015
 As shown: 70015002	1-way	High	Fixed	40055017	70055017
	3-way	Low	MST	40015000	70015000
	3-way	Low	Rotating Collar	40015002	70015002
	3-way	Low	Fixed	40015003	70015003
	3-way	Medium	Rotating Collar	40035002	70035002
 As shown: 70035009	3-way	Medium	Fixed	40035003	70035003
	3-way	Medium	RA – Right	40035009	70035009
	3-way	Medium	RA – Left	40035008	70035008
	3-way	High	Fixed	40055003	70055003
	3-way	High	RA – Right	40055009	70055009
 As shown: 70055008	3-way	High	RA – Left	40055008	70055008
	4-way	Low	MST	40015010	70015010
	4-way	Low	Rotating Collar	40015012	70015012
	4-way	Low	Fixed	40015013	70015013
 As shown: 70035013	4-way	Medium	Rotating Collar	40035012	70035012
	4-way	Medium	Fixed	40035013	70035013

# Guidewires

Guidewires are used for the percutaneous introduction of catheters.

## Types

1. Fixed Core Straight
2. Fixed Core J-Tip
3. Fixed Core Exchange
4. Movable Core J-Tip

## Options

- |  |   |   |   |  |
|--|---|---|---|--|
| <b>Diameter</b>  | <b>Length</b>   | <b>J Length</b>   | <b>Style</b>  | <b>Coating</b>   |
| <ul style="list-style-type: none"> <li>• 0.018"</li> <li>• 0.025"</li> <li>• 0.032"</li> <li>• 0.035"</li> <li>• 0.038"</li> </ul> | <ul style="list-style-type: none"> <li>• 60 cm</li> <li>• 145 cm</li> <li>• 150 cm</li> <li>• 260 cm</li> </ul> | <ul style="list-style-type: none"> <li>• 1.5 mm</li> <li>• 3.0 mm</li> <li>• 6.0 mm</li> <li>• 15.0 mm</li> </ul> | <ul style="list-style-type: none"> <li>• Long Taper</li> <li>• Long, Long Taper</li> <li>• Soft</li> <li>• Rosen</li> <li>• FS (Finger Straightenable)</li> <li>• FSEZ (Easy Finger Straightenable)</li> <li>• DE (Double Ended with Taper at Both Ends)</li> </ul> | <ul style="list-style-type: none"> <li>• PTFE (Teflon)</li> <li>• PTFE/HB (Heparin Coated Teflon)</li> </ul> |

## Part Numbers – Cardiology (Available Single Sterile or in Convenience Kits)

### 1. Fixed Core Straight

					Customer Order Part Number
Tip	Coating	Size	Length	Style	Part Number
Straight	PTFE	0.035"	145 cm	—	97000101
Straight	PTFE/HB	0.035"	145 cm	—	97000102
Straight	PTFE	0.038"	145 cm	—	97000103
Straight	PTFE/HB	0.038"	145 cm	—	97000104
Straight	PTFE	0.035"	145 cm	Long Taper	97000105
Straight	PTFE	0.038"	145 cm	Long Taper	97000106
Straight	PTFE	0.025"	145 cm	—	97000107
Straight	PTFE	0.018"	60 cm	Long, Long Taper	97000108
Straight	PTFE	0.025"	60 cm	Long, Long Taper	97000109
Straight	PTFE	0.038"	145 cm	Long, Long Taper	97000112
Straight	PTFE	0.032"	60 cm	Long, Long Taper	97000113
Straight	PTFE	0.035"	145 cm	Soft Wire	97000601
Benston	PTFE	0.035"	150 cm	—	96000603
Benston	PTFE	0.038"	145 cm	—	97000602

### 2. Fixed Core J-Tip

					Customer Order Part Number
Tip	Coating	Size	Length	Style	Part Number
1.5 mm J	PTFE	0.035"	175 cm	Rosen	97000201
3.0 mm J	PTFE	0.035"	145 cm	—	97000202*
3.0 mm J	PTFE/HB	0.035"	145 cm	—	97000203*
3.0 mm J	PTFE	0.038"	145 cm	—	97000205*
3.0 mm J	PTFE/HB	0.038"	145 cm	—	97000206*
3.0 mm J	PTFE	0.035"	145 cm	Long Taper	97000208
3.0 mm J	PTFE	0.035"	175 cm	—	97000210*
3.0 mm J	PTFE	0.038"	175 cm	—	97000211
3.0 mm J	PTFE	0.025"	145 cm	—	97000216
15.0 mm J	PTFE	0.035"	150 cm	FS	96000217
15.0 mm J	PTFE	0.035"	145 cm	—	97000217
15.0 mm J	PTFE/HB	0.035"	145 cm	—	97000219
3.0 mm J	PTFE	0.035"	145 cm	FSEZ	97000222
3.0 mm J	PTFE	0.032"	145 cm	—	97000232
3.0 mm J	PTFE/HB	0.038"	145 cm	Long Taper	97000233
6.0 mm J	PTFE	0.035"	145 cm	—	97000235
3.0 mm J	PTFE	0.038"	145 cm	DE	97000302
3.0 mm J	PTFE	0.035"	145 cm	DE	97000303
1.5 mm J	PTFE	0.035"	145 cm	DE	97000307
3.0 mm J	PTFE	0.035"	150 cm	FS	96000301
3.0 mm J	PTFE/HB	0.035"	150 cm	FS	96000303

### 3. Fixed Core Exchange

Customer Order  
Part Number

Tip	Coating	Size	Length	Style	Part Number
Straight	PTFE	0.035"	260 cm	—	97000401
Straight	PTFE	0.038"	260 cm	—	97000402
3.0 mm J	PTFE	0.035"	260 cm	—	97000405
3.0 mm J	PTFE	0.038"	260 cm	—	97000406

### 4. Movable Core J-Tip

Customer Order  
Part Number

Tip	Coating	Size	Length	Style	Part Number
3.0 mm J	PTFE	0.035"	145 cm	—	97000501
3.0 mm J	PTFE	0.038"	145 cm	—	97000503
3.0 mm J	PTFE/HB	0.038"	145 cm	—	97000504
3.0 mm J	PTFE/HB	0.035"	145 cm	—	97000505
3.0 mm J	PTFE	0.032"	145 cm	—	97000507
3.0 mm J	PTFE	0.038"	175 cm	—	97000508

### Part Numbers – Radiology (Only available in Convenience Kits)

Description	Tip	Coating	Size	Length	Style	Convenience Kit Part Number
Fixed Core Straight	Straight	PTFE	0.035"	150 cm	3 cm Taper	19600011
Bentson	Straight	PTFE	0.035"	150 cm	15 cm Taper	19600451
	Straight	PTFE/HB	0.035"	150 cm	15 cm Taper	19600751
	Straight	PTFE	0.035"	180 cm	15 cm Taper	19600471
	Straight	PTFE/HB	0.035"	180 cm	15 cm Taper	19600771
Newton	3 mm J	PTFE	0.035"	150 cm	15 cm Taper/FS	19600521
Rosen	1.5 mm J	PTFE	0.035"	150 cm	3 cm Taper	19600551
	1.5 mm J	PTFE	0.035"	180 cm	3 cm Taper	19600561
	1.5 mm J	PTFE	0.035"	260 cm	3 cm Taper	19600571
Fixed Core J-Tip	3 mm J	PTFE	0.035"	150 cm	3 cm Taper/FS	19600181
	3 mm J	PTFE/HB	0.035"	150 cm	3 cm Taper/FS	19600651
	3 mm J	PTFE	0.038"	150 cm	3 cm Taper/FS	19600182
	15mm J	PTFE	0.035"	150 cm	3 cm Taper/FS	19600221
	3 mm J	PTFE	0.035"	180 cm	3 cm Taper/FS	19600201
	3 mm J	PTFE/HB	0.035"	180 cm	3 cm Taper/FS	19600671
Movable Core J-Tip	3 mm J	PTFE	0.035"	150 cm	—	19600321
	3 mm J	PTFE/HB	0.035"	145 cm	7 cm Taper	19600001

# Interventional Devices and Accessories

The Encore® 26 Inflation Device is designed to offer exceptional performance under pressure.

## Product Specifications

### 1. Inflation Devices

- Available only in Fluid Management Convenience Kits

### 2. Y-Adaptors, 3. Tri-Adaptors

- Available in Convenience Kits and Single Sterile (except Gateway™ Y-Adaptor)

### 4. Torque Devices

- Available in Convenience Kits and Single Sterile (except The Grip™)

### 5. Guidewire Introducers

- Available in Convenience Kits and Single Sterile

### 6. Essentials™ Kit

- Available in Convenience Kits and Single Sterile

## Part Numbers

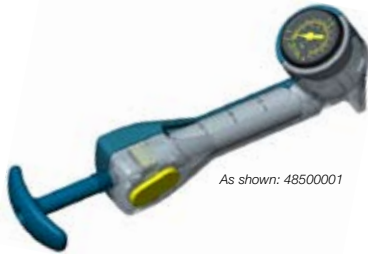

### 1. Inflation Devices

Device	Color	Pressure Range	Barrel Volume	Luminescent Gauge	Gauge	Latch Type	Threads	Customer Order Part Number	
								Convenience Kit Part Number	Single Sterile Part Number
Encore® 26	Teal and Yellow	0–26 ATM	20 ml	No	Angled/In-Line	Lock/Squeeze	13 threads/square inch, Engaged	48500001	Not Available
Aria™	Black	0–22 ATM	12 ml	Yes	Angled/In-Line	One-Handed	Engaged/Disengaged	41600002	Not Available
Aria™	Black	0–22 ATM	12 ml	Yes	Off-Line	One-Handed	Engaged/Disengaged	41600005	Not Available



# Interventional Devices and Accessories

## 2. Y-Adaptors



Examples	Description	ID	Threading	Customer Order Part Number	
				Convenience Kit Part Number	Single Sterile Part Number
 <p>As shown: 91400021</p>	Original Y* with NAMIC® Insertion Tool and NAMIC Torque Device	0.100"	5/16" x 28 threads/inch	41400021 w/10045075 and 41400303	91400021
	Original Y w/8" extension with NAMIC Insertion Tool	0.100"	5/16" x 28 threads/inch	41400023 w/10045075	91400023
 <p>As shown: 91400025</p>	Intermediate Thread Y with NAMIC Insertion Tool and NAMIC Torque Device	0.100"	5/16" x 20 threads/inch	41400122 w/10045075 and 41400303	64000122
	Large Bore Y with NAMIC Insertion Tool and NAMIC Torque Device	0.113"	5/16" x 28 threads/inch	41400123 w/10045075 and 41400303	64000123
	Large Bore Y w/10" ext. with NAMIC Insertion Tool and NAMIC Torque Device	0.113"	5/16" x 28 threads/inch	41400124 w/10045075 and 41400303	64000124
	Option 125™ Y* with NAMIC Insertion Tool and NAMIC Torque Device	0.125"	3/8" x 24 threads/inch	41400025 w/10045075 and 41400303	91400025
	Gateway™ Y	0.118"	3/8" x 24 threads/inch	48500002	Not Available

\*Tri-Adaptor also available (see below)

## 3. Tri-Adaptors

Description	ID	Threading	Customer Order Part Number	
			Convenience Kit Part Number	Single Sterile Part Number
Original Tri with NAMIC Insertion Tool and NAMIC Torque Device	0.100" main/ 0.093 side	5/16" x 28 threads/inch	41400031 w/10045075 and 41400303	91400031
Option 125 Tri with NAMIC Insertion Tool and NAMIC Torque Device	0.125" main/ 0.110" side	3/8" x 24 threads/inch	41400035 w/10045075 and 41400303	91400035

## 4. Torque Devices

Examples	Device	Color	Wire Size Accepted	Customer Order Part Number	
				Available in a Convenience Kit	Single Sterile Part Number
 <p>As shown: 91400300</p>  <p>As shown: 04487-20</p>  <p>As shown: H74902470012</p>	NAMIC Torque Device	Neon Yellow	0.010"-0.018"	Yes	91400300
	TD2® Torque Device	Yellow Body/White Tip	0.010"-0.018"	Yes	0448720
	The Grip™	Blue/Teal and White	0.014"-0.018"	No	0247001

## 5. Guidewire Introducers

Examples	Device	Color	Maximum Wire Used	Customer Order Part Number
				Single Sterile Part Number
 <p>As shown: 91400400</p>  <p>As shown: 04490-20</p>	NAMIC Introducer	Clear Hub	0.018	91400400
	Avenue® Insertion Tool	Yellow Hub (SciMed)	0.018	0449020

# Interventional Devices and Accessories

## 6. Essentials™ Kit

Examples	Description	ID	Threading	Customer Order Part Number	
				Convenience Kit Part Number	Single Sterile Part Number
	Essentials Kit:	0.118"	3/8" x 24 threads/inch	48500002	0449410
	Gateway™ Y-Adaptor			48500003	
	Avenue® Insertion Tool			48500004	

As shown: 48500002



As shown: 48500003



As shown: 48500004

# Table Covers, Patient Drapes & Fluoroscope Covers

*Table Covers are typically used to cover the “back” table in the sterile field.*

*Patient Drapes are typically used to cover a patient during a procedure and have cut-outs to access the patient.*

*Fluoroscope Covers are typically used to cover equipment in the sterile field.*

## Details

### 1. Table Covers

- Absorbable or non-absorbable

### 2. Patient Drapes:

- Absorbable or non-absorbable
- Cut-outs for access

### 3. Fluoroscope Covers:

- Flat Sheet
- Bouffant – Resembles a shower cap – typically used to cover the Image Intensifier (II)
- Regular – Resembles a garbage bag – typically used to cover the Shield

Table Covers, Patient Drapes and Fluoroscope Covers are not available Single Sterile.

## Part Numbers

### 1. Table Covers

Description	Convenience Kit Part Number
14 ½" wide x 25" long, absorbable with adhesive strips	10045306
42" wide x 40" long, absorbable	10045260
44" wide x 44" long, outside non-absorbable, inside absorbable	10046032
44" wide x 90" long, outside non-absorbable, inside absorbable	10027150
42" wide x 70" long, absorbable	10045304

### 2. Patient Drapes:

Description	Cut Out	Convenience Kit Part Number
24" wide x 26" long, non-absorbable	One in the middle of drape	10045275
30" wide x 42" long, absorbable	One in the middle of drape	10045307
40" wide x 60" long, absorbable	One for right leg	10045274
77" wide x 110" long, absorbable	One for each leg	10045268

### 3. Fluoroscope Covers:

Description	Tape	Style	Convenience Kit Part Number
36" wide x 44" long	Yes	Flat Sheet	10045225
36" wide x 38" long	No	Flat Sheet	10045276
18"	No	Bouffant	10045160
22"	No	Bouffant	10045163
27"	No	Bouffant	10045171
12" wide x 12" long	Yes	Regular	10045165
24" wide x 15" long	Yes	Regular	10045161
30" wide x 36" long	Yes	Regular	10045167
36" wide x 12" long	Yes	Regular	10045157

# Miscellaneous Products

## Categories

- Needles
- Packaged Caps (dead enders)
- Waste Containers
- Sharps Containers
- Scalpels
- Scissors
- Gauze Pads
- Forceps
- Connectors/Adaptors
- Miscellaneous

## 1. Needles

**1A. Vascular Access Needles** are used to access arteries and veins

**1B. Hypodermic Needles** are used to deliver medications



- 18, 19, 20, or 21 Gauge
- One or two part
- With or without shield; shields bow tie shaped or kidney shaped
- Varying lengths from 1½" to 2⅞"
- As gauge increases, needle size decreases
- Not available Single Sterile

## 2. Miscellaneous

### 1A. Vascular Access Needles (Only available in Convenience Kits)

Examples	Gauge	Parts	Wings	Needle Length					
				Non-Safety					Safety
				1½"	2½"	2¾"	2⅞"	2⅞"	2¾"
 <p>As shown: 10055047</p>	18	1	No	10055024	—	10055047	—	—	106000521
	—	—	—	—	—	10055015	—	—	—
 <p>As shown: 10055046</p>	18	1	Yes	—	—	10055046	—	—	—
	18	2	Yes	—	—	10055002	10600080	10027266	—
	18	3	Yes	—	10055018	—	—	—	—
	19	1	No	10055025	—	10055044	—	—	—
	20	1	No	10055026	—	—	—	—	—
	21	1	No	10055027	—	—	—	—	10045547

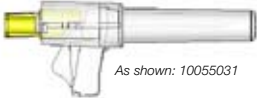
### 1B. Hypodermic Needles (Only available in Convenience Kits)

Examples	Gauge	Needle Length						
		Non-Safety				Safety		
		⅝"	1"	1½"	1½" w/filter	⅝"	1"	1½"
 <p>As shown: 10055031</p>	16	—	—	10055013	—	—	—	—
	18	—	—	10027154	10055001	—	10055031	10055029
	19	—	—	10055007	10045352	—	10055032	10055033
	20	—	—	10027158	—	—	10055034	10055035
	21	—	—	10027157	—	10055036	10055037	10055038
 <p>As shown: 10055003</p>	22	—	10055022	10055003	—	—	10055039	10055040
	23	—	—	10055011	—	10055042	10055041	—
	25	10027155	—	10027156	—	10055030	10055043	—
	26	10055012	—	—	—	—	—	—



## 2. Miscellaneous

Examples	Category	Description	Customer Order Part Number	
			Convenience Kit Part Number	Single Sterile Part Number
 <p>As shown: 90510002</p>	Packaged Caps	(4) Universal/Dead Enders	(4) 10027000	64000001
	Waste Containers	Waste Container	90510002	90510002
	Sharps Containers	Single Needle Holder	10045322	Not Available
		Sharps Shuttle*	10045323	Not Available
		Temporary Needle Holder*	10045704	90510001
	Scalpels	#11 Short Handle	10045371	Not Available
		#11 Safety with Handle	10045373	Not Available
		#15 Safety with Handle	10600523	Not Available
		#11 with Handle	12700401	Not Available
		#15 with Handle	12700402	Not Available
#11 Blade Only		12700404	Not Available	
Scissors	#15 Blade Only	12700405	Not Available	
	Scissors	10045428	Not Available	
Gauze (Specify Quantity)	2" x 2"	10045389	Not Available	
	4" x 4"	13000107	Not Available	
Forceps (Looks Like Tweezers)	Forceps, Metal	10045374	Not Available	
	Forceps, Plastic	10045394	Not Available	
	Reflux Valve (Pouch)	40400102	Not Available	
Connectors/Adaptors	Male to Rotating Adaptor	40027180	70027180	
	Female to Rotating Adaptor	40044103	Not Available	
	Female to Female Tubing 2"	40705101	90705101	
	Male to Male Tubing 2"	40705202	90705202	
Other Miscellaneous	Bag Decanter	10045119	Not Available	
	Contrast Removal Valve	41300020	91300020	
	Hemo Band	10045168	Not Available	
	Strap Clip	10045242	Not Available	
	Towel, 15" x 24"	10045308	Not Available	
	Hemostats, 5# (Matte Finish, Straight)	10045581	Not Available	
	Suture Driver (Silky Finish, Straight)	10045582	Not Available	
	50 cc Bottle Hanger	10046007	64046007	
	Medicine Cup (Holds 60 ml)	13000104	Not Available	
	Emesis Basin	13000108	Not Available	

As shown: 90510002



As shown: 90510001

\*Holds Several Needles





Navilyst Medical, Inc.  
26 Forest Street  
Marlborough, MA 01752  
[www.navilystmedical.com](http://www.navilystmedical.com)

*For more information, call*  
**800.833.9973**

© 2009 Navilyst Medical, Inc., or its affiliates.  
All rights reserved.

Angio-Sac, claraCIL, Compensator, Essentials, flexCIL, Perceptor, Protection Station, Squeeze Contrast Controller are trademarks of Navilyst Medical, Inc.  
All other product names, brand names and trademarks are trademarks or registered trademarks of their respective owners.

NAVM340 / 7.5M / 06/09